

THESE DRAWINGS AND SPECIFICATIONS ARE THE PROPERTY OF JAMES B. LANSING SOUND INC. THEY ARE ISSUED IN STRICT CONFIDENCE AND SHALL NOT BE REPRODUCED, COPIED, OR USED AS THE BASIS FOR MANUFACTURE OR SALE OF APPARATUS WITHOUT PERMISSION.

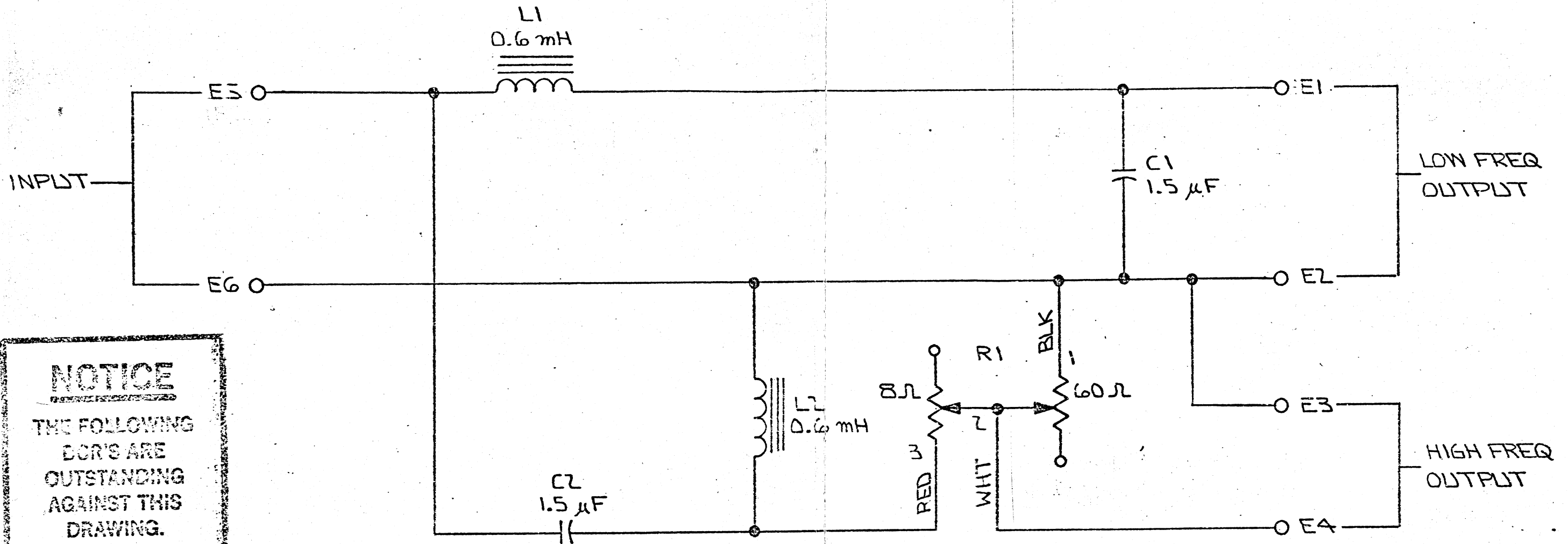

NOTICE
THE FOLLOWING
DOR'S ARE
OUTSTANDING
AGAINST THIS
DRAWING.

FILE COPY

1. FOR WIRING DIAGRAM SEE DWG. 10463.
NOTES: UNLESS OTHERWISE SPECIFIED

				UNLESS OTHERWISE SPECIFIED DIMENSIONS ARE IN INCHES. BREAK SHARP EDGES .015			DRAWN: 6/31/77 S. Hallman		TITLE: SCHEMATIC-N7000		
				DECIMALS .XX±.01		FRACTIONS X/Y±1/32		CHECK: 18, Nov. 77 Belmont Conington		DESIGN:	
				MATERIAL:		ENGR: 12-1-77		SIZE: B		DRAWING NUMBER: 11134	
				TREATMENT:		APPR: 3 DEC 1977		SCALE: X		WEIGHT: X	
				MACHINE FINISH: V		DO NOT SCALE DRAWING		SHEET: 1		OF: 1	
REV	ECN	LET.	CHANGE	DATE	BY	APPLICATION	QTY	MODEL	NEXT DWG	REV	
5520	C		WHT. LEAD WAS GRN	2/4/79	AKB			N7000			
6968	B		REV & REDRAWN	12-1-77	AKB						

THESE DRAWINGS AND SPECIFICATIONS ARE THE PROPERTY OF JAMES R. HANCOCK ENGINEERING CO. THEY ARE ISSUED IN STRICT CONFIDENCE AND SHALL NOT BE REPRODUCED, COPIED, OR USED AS THE BASIS FOR MANUFACTURE OR SALE OF APPARATUS WITHOUT PERMISSION.

NOTICE
THE FOLLOWING DCS'S ARE OUTSTANDING AGAINST THIS DRAWING.

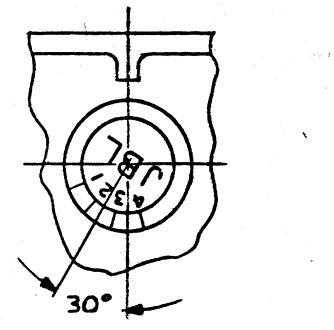
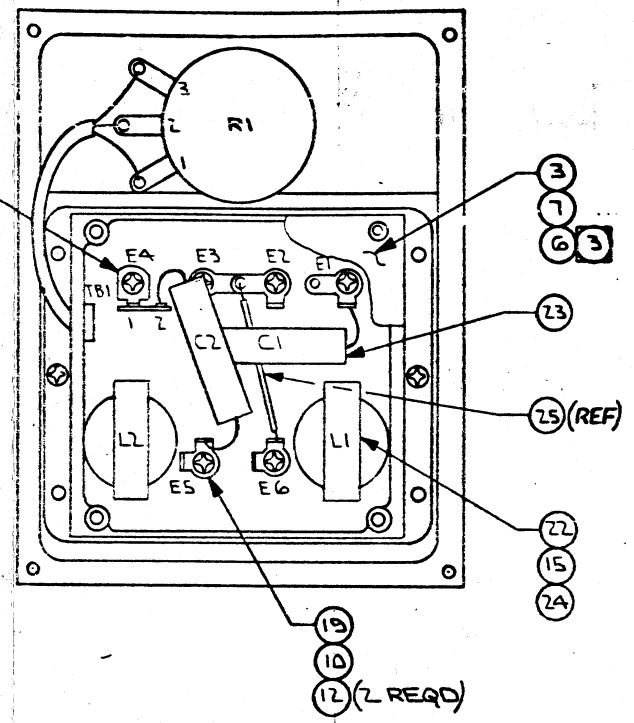
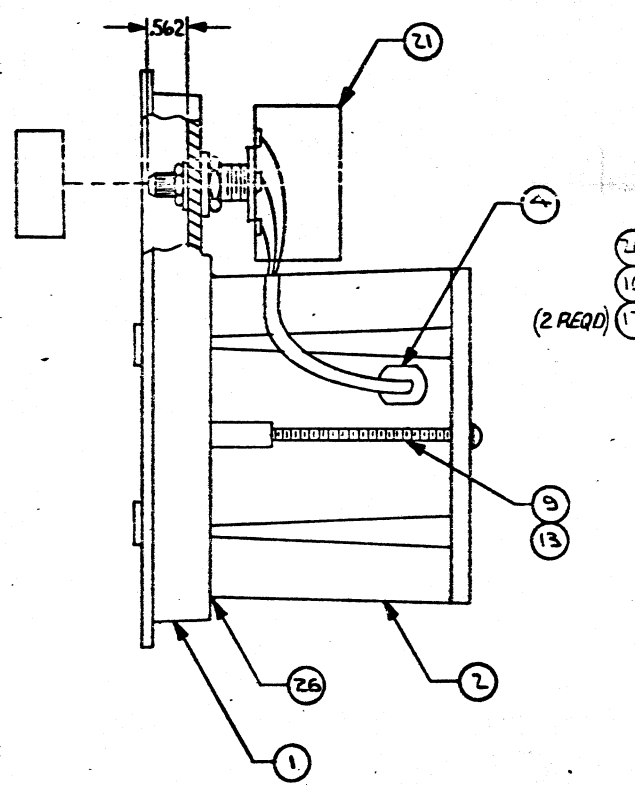
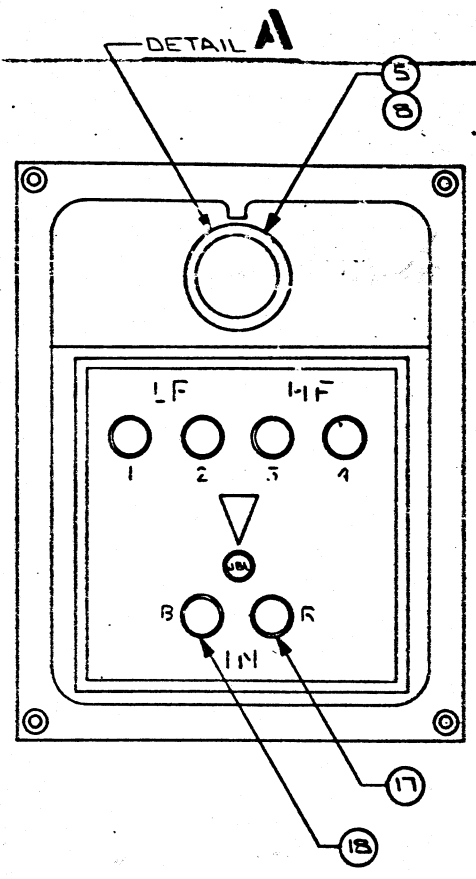

DETAIL A
SCALE: NONE

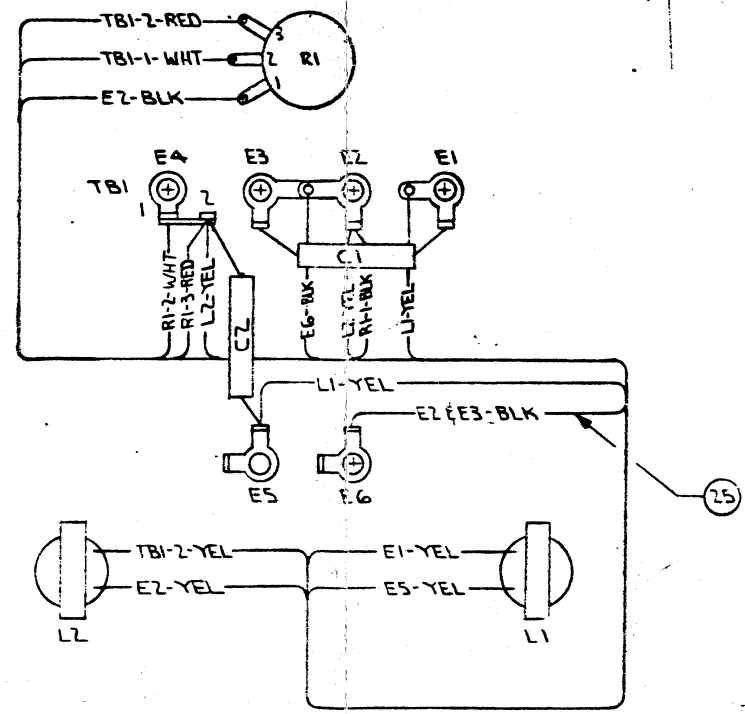

WIRING DIAGRAM

ITEM	PART NUMBER	DESCRIPTION	QTY	REMARKS
28	474175	POWDER, ADDITIVE	A/R	
27	294545	DYE, DYKEM BLUE STEEL	A/R	
26	293685	ADHESIVE	A/R	EDS 1002
25	10298	WIRE, 20 AWG, BLK, 2 1/2	1	
24	103245	SLEEVING, NO. 14, YEL	A/R	
23	10460	CAPACITOR, 1.5 μF	2	C1, C2
22	13222	INDUCTANCE COIL, 0.6 mH	2	L1, L2
21	13359	L-PAD ASSY	1	R1
20	10212	TERMINAL STRIP, 2 TERM.	1	TB1
19	10241	SOLDER LUG, Y-TYPE	5	
18	10244	BINDING POST, BLK	5	E1, E2, E3, E4, E6
17	10243	BINDING POST, RED	1	E5
16				
15	61961	ADHESIVE	A/R	
14				
13	10280	WASHER, LOCK, NO. 6, INTERNAL	2	
12	10817	WASHER, NO. 6, INSULATING	12	
11				
10	10811	SCREW, 6-32 X 3/8, PH HD PHIL	6	
9	10281	SCREW, 6-32 X 2 1/4, RD HD PHIL	2	
8	12961	SCREW, SET, 6-32 X 1/4, SOC HD	1	
7	53613	RIVET	4	
6	57415	FOILCAL	1	MRD 57402
5	10330	KNOB	1	MRD 47074
4	12274	STRAIN RELIEF	1	
3	10302	BOTTOM LID	1	
2	10316	NETWORK CONTAINER	1	MRD 47077
1	50403	MOUNTING PLATE	1	MRD 47068

BILL OF MATERIAL

8. COMBINE ITEMS 26, 27, & 28 PER EDS 1004.
 7. KNOB TO BE INSTALLED IN POSITION SHOWN WHEN POT IS IN A FULL COUNTER-CLOCKWISE POSITION.
 6. ITEM 19 IS USED WITH E1, E2, E3, E5, E6.
 5. WIRE IDENT. CODE:

TB1-1-GRN/BLK	TRACE COLOR
---	WIRE COLOR
---	TERMINATION
---	DESTINATION
 4. ASSEMBLE ITEM 2 TO ITEM 1 & SEAL UNIT ALL AROUND WITH ITEM 14.
 3. CENTRALLY LOCATE ITEM 6 ON ITEM 3, FOILCAL TO READ RIGHT WHEN POT IS DIRECTLY ABOVE IT.
 2. FOR ENGINEERING SPEC SEE E.S.T. 1025
 1. FOR SCHEMATIC SEE DWG NO. 11134.
- NOTES: UNLESS OTHERWISE SPECIFIED

UNLESS OTHERWISE SPECIFIED DIMENSIONS ARE IN INCHES. BREAK SHARP EDGES .015		DRAWN: JAMES R. HANCOCK	
DECIMALS	FRACTIONS	ANGULAR	CHECK: J. HANCOCK
XX=01	XX=005	X/X=1:32	DESIGN: J. HANCOCK
TIT	MATERIAL:	ENGR:	APP: J. HANCOCK
TREATMENT:	MACHINE FINISH V	DO NOT SCALE DRAWING	SCALE: FULL
DATE: 11/27/77	BY: J. HANCOCK	APPLICATION:	WEIGHT: 7
REV: 1	CHANGE:	DATE:	BY:

MRD 57402
MRD 47074
MRD 47077
MRD 47068

ITEM: WIRING DIAGRAM, N7000
DRAWING NUMBER: 10463
REV: V
SHEET 1 OF 1

JBL N400

Crossover frequency... 500 cps
 Impedance 16 ohms
 Shipping weight..... 10 lbs.
 This network is used in highest quality maximum-efficiency loudspeaker systems such as the JBL 080, 081, and 085. The N400 matches the characteristics of the incomparable 375 high frequency driver to those of a single 150-4C bass driver, or two 150-4's.

JBL N600

Crossover frequency... 600 cps
 Impedance 16 ohms
 Shipping weight..... 9½ lbs.
 Designed for use with the JBL 130A or two 130B bass drivers and the 275 high frequency driver. The N600 is a part of the JBL 205 system — a combination of precision transducers which delivers outstanding stereo reproduction in the JBL-Ranger METREGON.

JBL N1200

Crossover frequency.. 1200 cps
 Impedance 16 ohms
 Shipping weight..... 9 lbs.
 The N1200 is used with the JBL 175DLH high frequency assembly and the 130A bass driver in the famous JBL 001 loudspeaker system. This network also balances the 175DLH with two 130B bass drivers in the JBL 050 system. The N1200 is one of the most popular professional networks ever made available to the audiophile.



Models N400, N600 and N1200 are husky networks individually tested to meet exacting production standards. A 3-position switch adjusts the intensity of the high frequency transducer in 3 db steps. An autotransformer is used for high frequency control rather than resistive pads. The tapped transformer maintains tight coupling between the high frequency driver and the amplifier no matter where the switch is set.

These networks give 12 db per octave attenuation on each side of the crossover frequency when used with recommended JBL transducers.

Case measures 4¾" x 6" x 4-11/16"

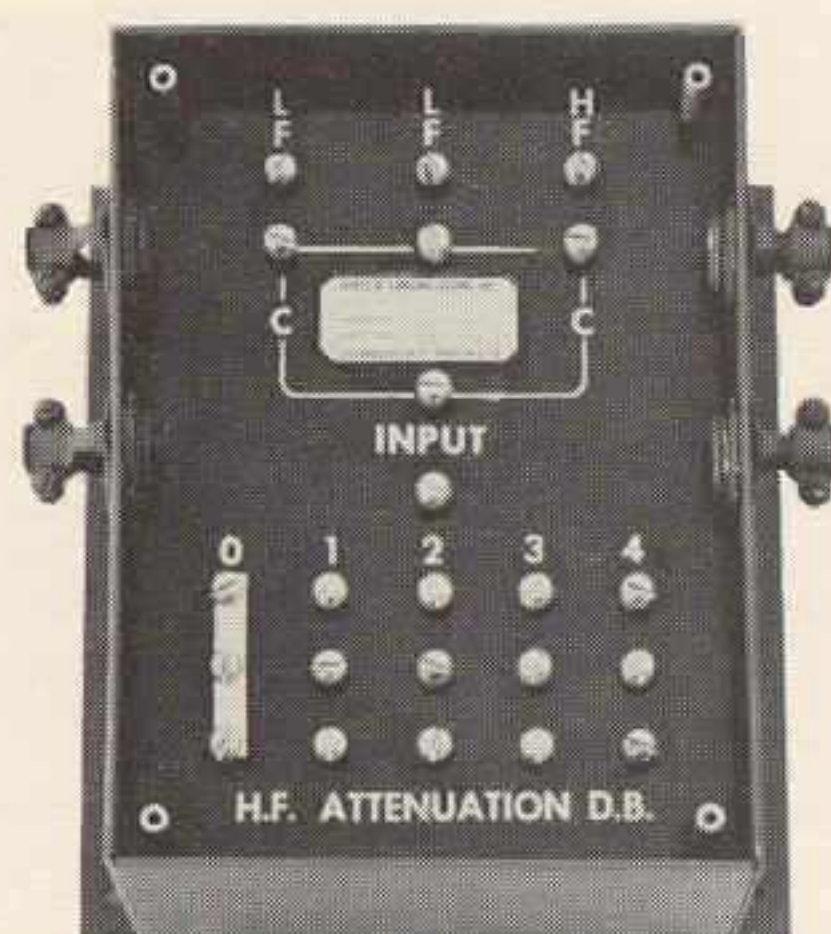

JBL N500

This 500 cycle network is designed for maximum efficiency theater systems using 150-4 or 150-4C bass drivers and the 375 high frequency driver. The N500 has extremely low insertion loss and will handle high power levels without distortion — features which make it especially suited for theater work. High frequency attenuation is adjusted by a strapping bar in four 1 db steps. Cable clamps and metal cover for the case are included. Case measures 6" x 8" x 6". Shipping weight — 16 lbs. Attenuation — 12 db per octave on each side of crossover.

N400 N1200
 N500 N2400
 N600 N2600
 N7000

**DIVIDING
 NETWORKS**

Dividing networks are used in two-way loudspeaker systems to electrically channel low tones to the bass loudspeaker, high notes and overtones to the high frequency transducer.

JBL precision dividing networks use circuits carefully designed to give an imperceptible transition from low to high frequency transducers.

Each network is specifically engineered to match the characteristics of the JBL transducers with which it is used.

JBL

JBL

N400 N1200
N500 N2400
N600 N2600

N7000

**DIVIDING
NETWORKS**

If a dividing network is to fulfill its function without compromise, it must be able to handle extreme variations in dynamics, the full range of audio frequencies, complex transients, and the varying impedance of a loudspeaker load.

JBL networks are designed and tested by acoustical measurements of the actual loudspeaker systems with which they are used. Circuit values are adjusted until acoustic response is uniform through the crossover region. Thus, the effects of individual speaker characteristics, impedance fluctuations, and the physical separation of the two sound sources are all taken into account in the final system design.

Naturally, such sophisticated engineering demands very close production tolerances if full benefit is to be derived from the complex circuitry. Ordinary networks often use electrolytic capacitors with tolerances of plus or minus 20%. Such networks exhibit rough response through the crossover region, and characteristics vary greatly from unit to unit.

All JBL networks use hand-wound aluminum foil capacitors (not electrolytic units) which meet tolerances of plus or minus 1%. The low-loss inductors used in JBL networks are also held to production tolerances of plus or minus 1%.

Models N2400, N2600, and N7000 are mounted on a cast aluminum excutcheon for easy installation in a single hole cut in the mounting board. A continuously variable control is provided so that the intensity of the high frequency transducer can be adjusted for optimum balance to suit your personal listening taste and to compensate for the effect of room acoustics.

These networks give 12 db per octave acoustic attenuation on each side of the crossover frequency when used with recommended JBL transducers.

Case measures 4³/₄" x 6" x 3¹/₂"

JBL N2600

This network is designed to match the 075 high frequency transducer to one or two extended-range speakers (JBL D130, D131, D123, D216). Impedance selecting switches allow multiple speakers to be connected to either the high frequency or low frequency terminals, provided the effective impedance of the combination totals 16 or 32 ohms. For example, the N2600 will match the 075 to a single D123 loudspeaker. If you later wish to add a second D123, the two cone speakers are connected in series, and the LF switch on the N2600 is changed to the 32 ohm position.

JBL N7000

The N7000 provides a means of adding the 075 to existing high-quality two-way loudspeaker systems where it is desired to extend the high frequency performance of the system beyond human audibility. This is valuable in live program monitoring and other applications where clean, extended high frequency material is present in the program source. By using a frequency of 7000 cps for the upper crossover point, the 075 reproduces only the delicate overtones. There is no effect of having an instrument suddenly "jump" from one reproduce to another.

JBL dividing networks are designed so that the transducers used will exhibit a 12 db per octave rolloff on each side of the crossover frequency. The figure of 12 db per octave was chosen on the basis of both theoretical considerations and actual acoustic measurements with JBL units.

Experiments indicate that rolloff rates less than 12 db per octave do not sufficiently isolate the low and high frequency channels — sound from the two transducers overlaps and gives rise to interference and ragged response. On the other hand, circuits giving rolloff rates greater than this figure may introduce "ringing" and transient distortion.

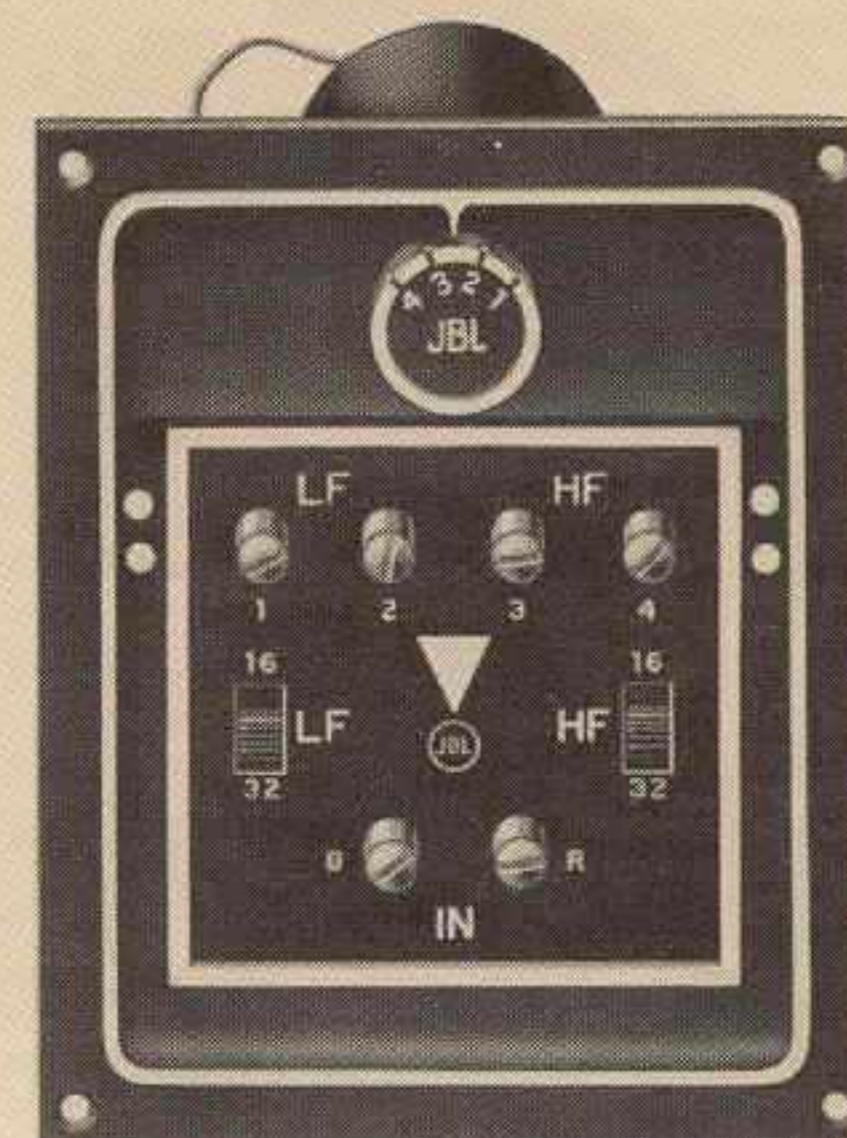

Crossover frequency . . . 2500 cps
Input impedance 16 ohms
Output impedance 16 or 32 ohms
(switch-selected at HF and LF posts)
Shipping weight 3³/₄ lbs.

Crossover frequency . . . 7000 cps
Impedance 16 ohms
Shipping weight 3 lbs.

JBL N2400

Identical to Model N2600, except without impedance selecting switches.

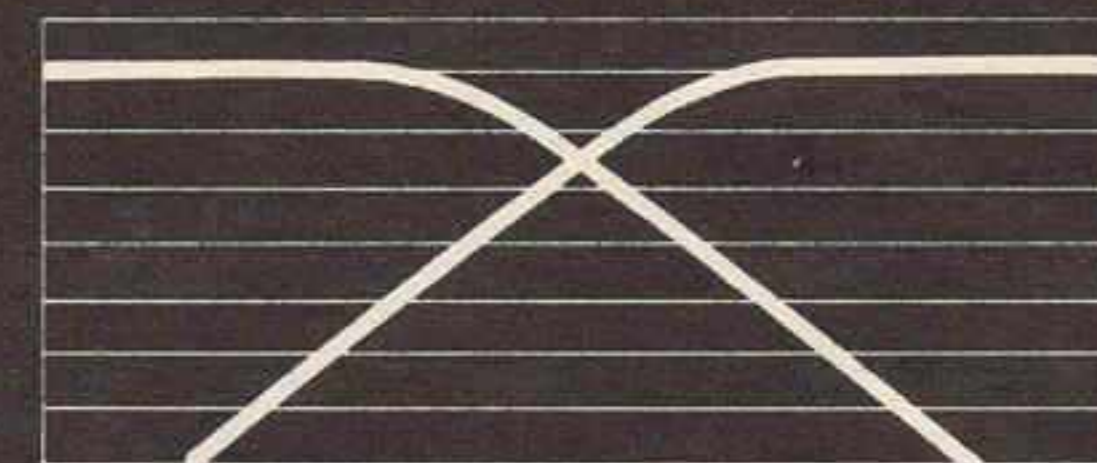

12 db PER OCTAVE CROSSOVER CURVE

For information concerning other applications to JBL Dividing Networks, write to Technical Service Department, James B. Lansing Sound, Inc. In submitting problems, please supply all details concerning desired use.

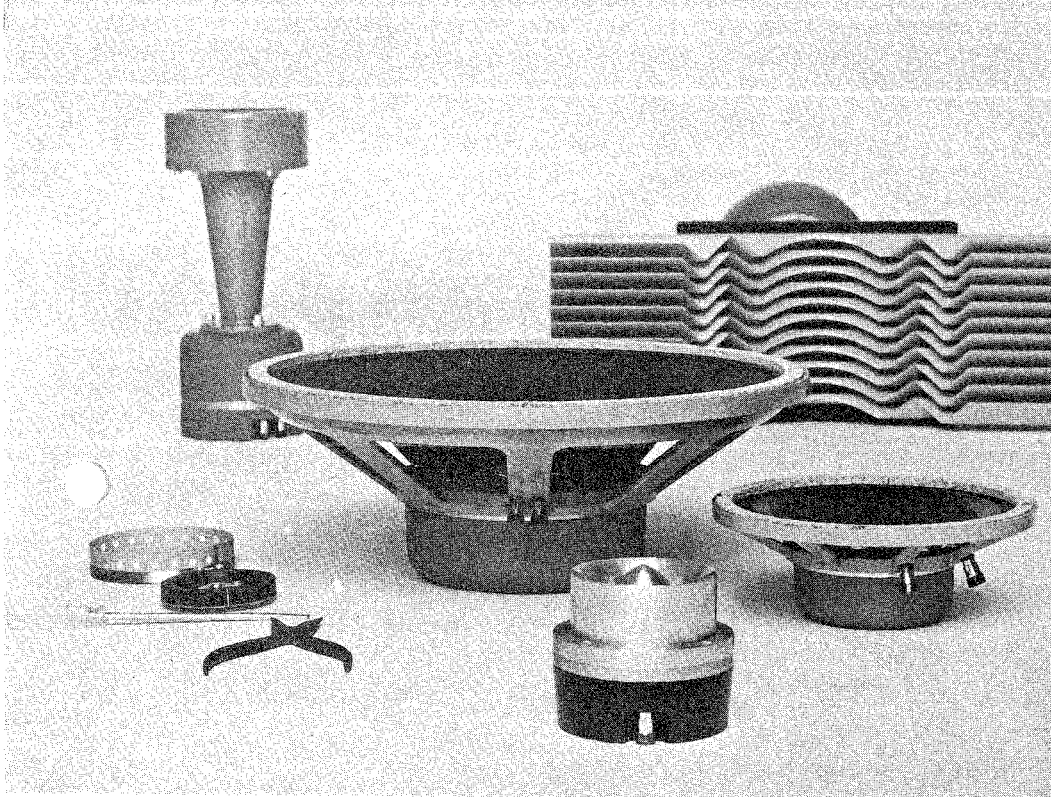

PUBLICATION OM22-3

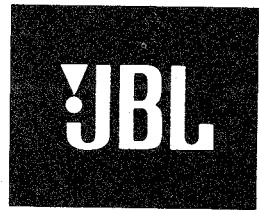

JBL DIVIDING NETWORK INSTRUCTION MANUAL

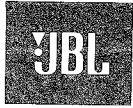

James B. Lansing Sound, Inc. maintains a Technical Service Department to help JBL owners with their individual problems. If you cannot find the answer you need in published JBL literature or obtain it from your Audio Specialist, please write us.

All JBL precision transducers are fully guaranteed against defects in materials and workmanship. Be sure to fill out and mail the warranty card immediately.

APPLICATION

JBL precision networks use circuits carefully designed to give an imperceptible transition from low to high frequency transducers. Unlike ordinary all-purpose networks, each JBL circuit is specifically engineered to match the characteristics of the JBL transducers with which it is used, and should not be connected to components for which it is not designed. Components which match each of the JBL dividing networks are listed in the table below:

NETWORK MODEL	CROSSOVER FREQUENCY	LOW FREQUENCY TRANSDUCER	HIGH FREQUENCY TRANSDUCER	HIGH FREQUENCY CONTROL	INPUT IMPEDANCE (OHMS)	SHIPPING WEIGHT (LBS.)
N500	500	150-4's 150-4C	375	Strapping Bar	16	16
LX5	500	LE15A	375, LE175, LE85	3-position switch	8	10
LX7	500	LE14A	LE175	3-position switch	8	10
N1200	1200	D130, D131, 130A, 130B's	LE175	3-position switch	8	9
LX10	1500	LE14A	LE175	Continuously variable	8	3
LX8	2000	LE14A	LE20	3-position switch	8	3
LX11	2500	LE10A	LE20	3-position switch	8	3
LX2	2500	D123, D208, D216	LE20	Continuously variable	8	3
N2400	2500	D130, D131, D123	075	Continuously variable	8	4
N7000	7000	Any two-way system	075	Continuously variable	4 to 16	3

SOPHISTICATED CIRCUITRY

Dividing networks are used in two-way loudspeaker systems to electrically channel low tones to the bass loudspeaker and high notes and overtones to the high frequency transducer.

If a dividing network is to fulfill its function without compromise, it must be able to handle extreme variations in dynamics, the full range of audio frequencies, complex transients, and the varying impedance of a loudspeaker load.

JBL dividing networks are carefully designed to complement the exact characteristics of the JBL transducers with which they are to be used. Each network circuit controls the signal to the high and low frequency transducers in such a way that smooth acoustic response is maintained through the full audio spectrum. Thus, the effects of individual speaker characteristics, impedance fluctuations, and the physical separation of the two sound sources are all taken into account in the complete system design.

Naturally, such sophisticated engineering demands very close tolerances in production if all the benefits of the design approach are to be realized. Ordinary networks, for example, often use electrolytic capacitors with tolerances of plus or minus 20%. Response through the crossover region is ragged, and characteristics vary from unit to unit.

All JBL networks, on the other hand, use only non-inductive paper or mylar dielectric capacitors (not electrolytic units) individually tested to meet JBL tolerances. The special inductors used in JBL networks have extremely low insertion loss so that none of the driving power to the loudspeaker system is wasted in the network. Each inductor is calibrated on a sensitive electronic bridge and its value set precisely. To meet JBL production tolerances, network components must check out within plus or minus 1% of the established design value.

MOUNTING IN JBL ENCLOSURES

JBL dividing networks are normally installed in the back panel of the loudspeaker enclosure. In JBL enclosures, they may be easily installed directly into the mounting hole which is provided. Make sure that the white tubular gasket is in place around the network flange. Center the network into the mounting hole and secure by driving four #6 x $\frac{3}{4}$ " round head wood screws into the outside surface of the panel. (To install the LX4-2 network into the standard cutout, the F2 mounting flange is required.)

MOUNTING IN CUSTOM ENCLOSURES

Dimensions for the required mounting hole are shown in the diagram. (To mount the LX4-2 in a cutout of this size, the F2 mounting flange is required.)

If you mount the network in the same compartment as the low frequency driver, make sure that the mounting hole is cut exactly. Otherwise, the white tubular mounting gasket will not seal properly, and the resulting air leaks may introduce objectionable hisses and whistles into the system.

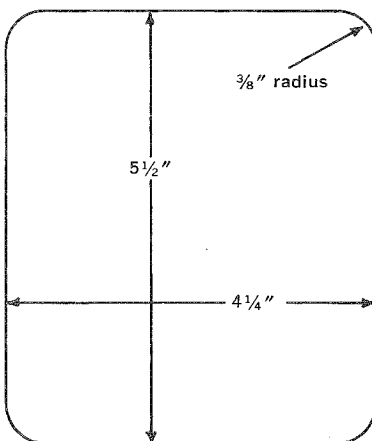

ADJUSTING HIGH FREQUENCY GAIN

Since the high frequency characteristics of rooms cannot be predicted, each JBL dividing network is provided with a high frequency level control, which makes it possible to achieve a realistic tonal balance under a variety of room conditions. The acoustics of your listening room and your personal listening taste will dictate the setting which will provide the most pleasing performance.

The control enables you to adjust the power fed to the high frequency transducer. It does not affect the crossover frequency, nor does it limit the upper frequency response of the loudspeaker system.

Some experimentation with this control is usually necessary when the system is first installed in its permanent location. If musical reproduction seems to be shrill and edgy, turn the control counterclockwise to a lower setting. If it seems dead and dull, turn clockwise to a higher setting. Comparative listening tests should be made at the usual listening location. Once the control is set for best overall results, it need not be changed. You can compensate for additional differences in source material with your preamplifier controls.

THE MODEL N500

The JBL N500 dividing network is a professional unit designed primarily for theater installations. It is usually mounted on top of the enclosure or in some other visible and convenient location.

All terminal screws lying on the white line are common. The output screws on this line should be connected to the black speaker terminals. The two screws marked "LF" are internally connected so that connecting an LF driver to each set of posts effectively connects the drivers in parallel.

The gain of the high frequency unit may be adjusted by changing the position of the strapping bar. Zero position provides the maximum intensity level of the HF unit. Each successive step lowers the HF level one db.

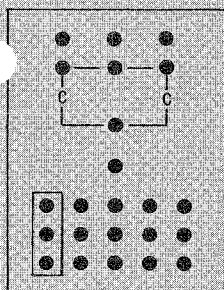

CONNECTING JBL NETWORKS

NETWORK IMPEDANCE All JBL dividing networks are matched to the characteristic impedance of the transducers with which they are used. Model N500 is a 16-ohm network and should be connected to the 16-ohm amplifier tap for most efficient power transfer. All other JBL networks will operate most efficiently when connected to the 8-ohm amplifier tap, although the 4-ohm or the 16-ohm tap can be used without danger of damage to amplifier or loudspeakers.

WIRE SIZES In factory-installed JBL systems, 18-gage stranded insulated wire is used for connection of components. In home installations, 18-gage stranded or solid wire or ordinary commercial lampcord may be used for speaker-amplifier connections up to 50 feet.

CONNECTING TO AMPLIFIER Fasten the leads from your amplifier to the two push-type terminal posts on the face of the dividing network.

The "B" or black post connects to the black, or common, lead. The "R" or red post connects to the 8 or 16 ohm amplifier tap. No soldering is required. Simply depress the colored button, insert the bare end of the lead wire, and release.

CONNECTING TO SPEAKERS Most JBL networks are mounted on an escutcheon plate which fits into the standard mounting cutout on the enclosure. Lead wires from the speakers are brought out to the push-type terminal posts on the panel through eyelets in the escutcheon plate.

Proper connections of speakers to the various JBL networks are explained below. Care should be taken to follow connecting instructions exactly to ensure that the system will operate in phase: that is, so that a signal from the amplifier will cause both diaphragms to move in the same direction at the same time.

CONNECTING THE LX11 Emerging from the chassis of the LX11 network are four wires: two black, one green and one red. Connect the green wire to the red terminal post of the LE10A low frequency loudspeaker. Connect the red wire to the red terminal post of the LE20 high frequency transducer. Connect the black wires to the black posts of the speakers. Since these two wires are connected in the internal circuitry of the network, either black wire may be connected to either speaker.

CONNECTING THE LX8 The LX8 network is connected in the same way as the LX11. Connect the green wire to the red terminal post of the LE14A low frequency loudspeaker. Connect the red wire to the red terminal post of the LE20 high frequency transducer. Connect the black wires to the black posts of the speakers — either wire to either speaker.

CONNECTING THE N400, N1200, N2400 and LX2. Each of these four dividing networks is connected as shown in the diagram below:

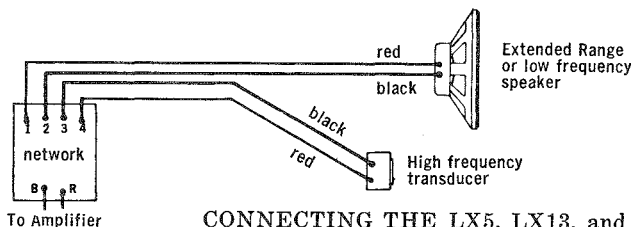

CONNECTING THE LX5, LX13, and LX10. These networks are connected to speakers as shown in the diagram below:

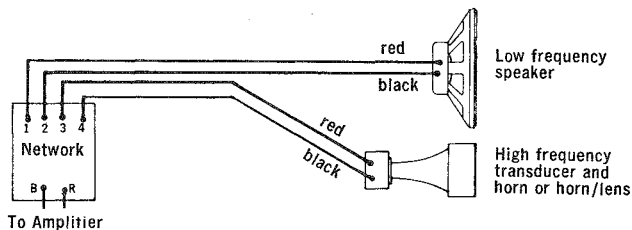

CONNECTING THE N7000 The N7000 dividing network provides a means of adding the 075 to existing high-quality two-way loudspeaker systems to obtain added brilliance in the very high frequencies. It is connected to the high frequency terminals of the main dividing network as shown in the diagrams below:

